

GUTTER PROTECTION FOR 5 IN. GUTTERS WITH ZIP SCREWS HANGERS

PRODUCT

- Product for existing rain gutters
- Protects from leaves, debris, snow and ice
- Sturdy weatherproof structure
- Prevents leaks
- 25-year anti-clog warranty
- Package contains:
-7.44' (2.27 m) x 43 pcs = 320' (97 m)

PERFORATIONS

- 7/64" (2.8 mm) in diameter
- Drains 29.7" (754 mm) of water per hour
- Offers the perfect balance between maximum drainage and debris protection

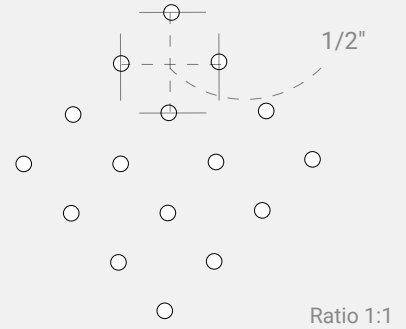

ALUMINUM

- Colour: Carbon Black B95
- Grade: 3105 H24
- Thickness: 0.0175" (including finish)



View the results of our independent drainage, resistance, and wind tunnel tests at www.alu-rex.com/en/tests.

Tolerances

x.xxx" = +/- 0.005" (0.127 mm)
x.xxxx" = +/- 0.0005" (0.0127 mm)

5" GUTTER PROFILE

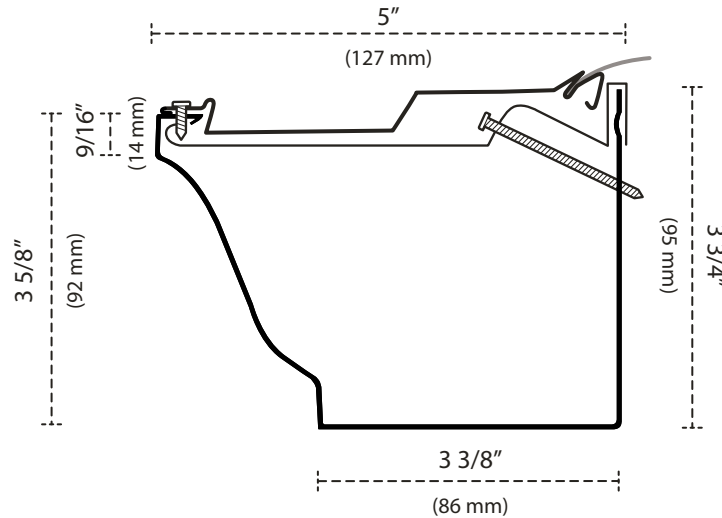

This product is protected by a number of patents.

PROFILE

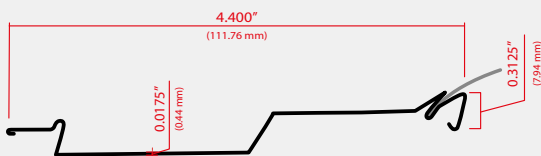

FLEX SEAL TECHNOLOGY

- Back of the gutter is watertight
- Resistant to UV rays and changes in temperature
- Protection against mold
- Unique patented technology

